

VBI31... DN20...40 (PN10)  
 VBG31... DN20...40 (PN10)  
 VBF21... DN40...50 (PN6)

Seria 02



**1**

		4290202
VBI31...		
		300201
VBG31...		
		4260216
VBF21...		

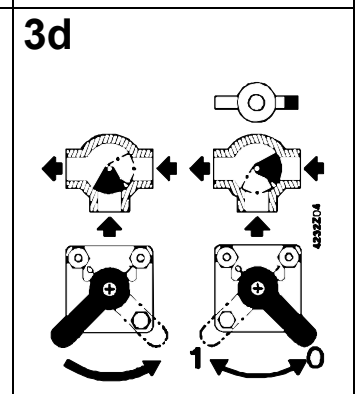
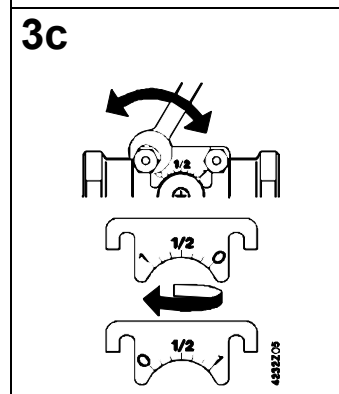
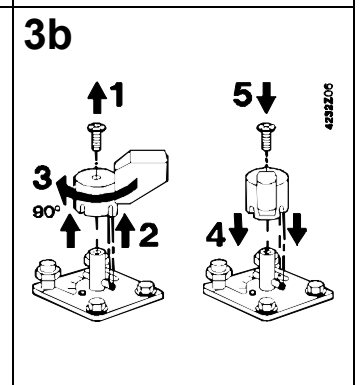
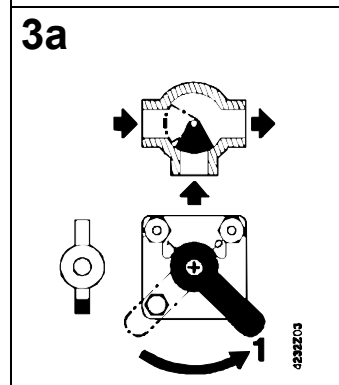
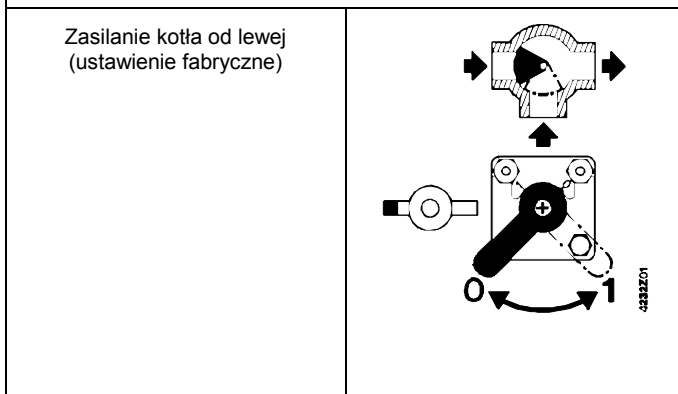
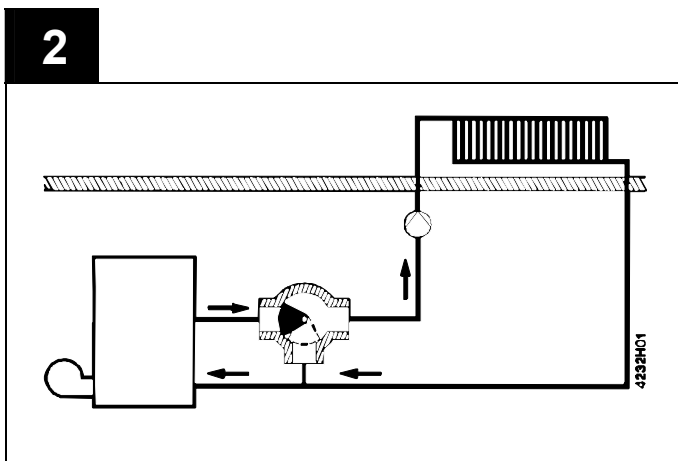
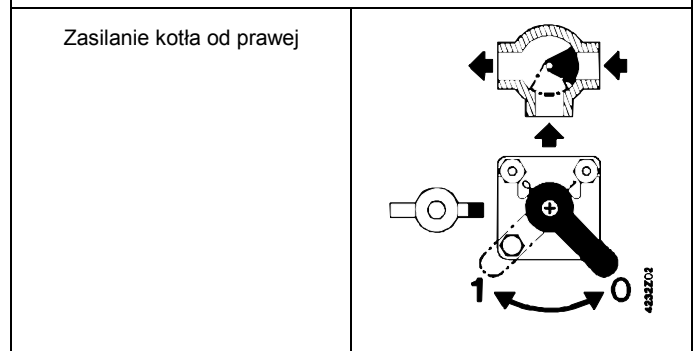
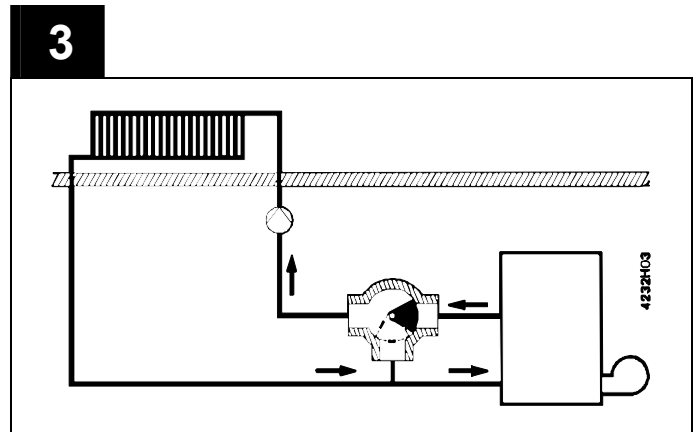

VCI31... DN20...40 (PN10)

Seria 02

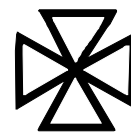

1

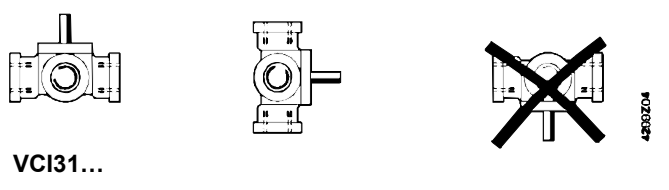

3

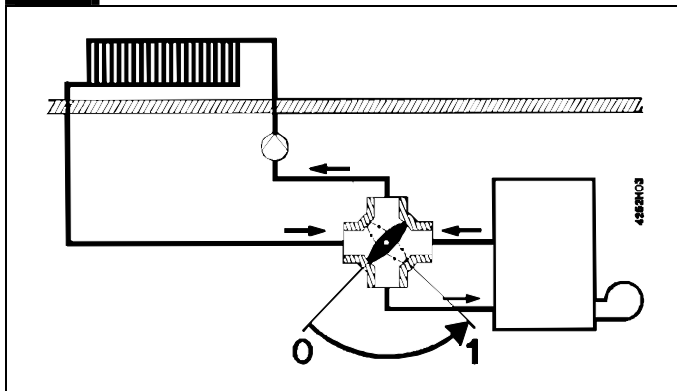

Zasilanie kotła od prawej

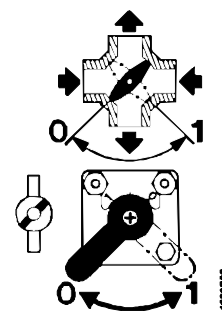

2

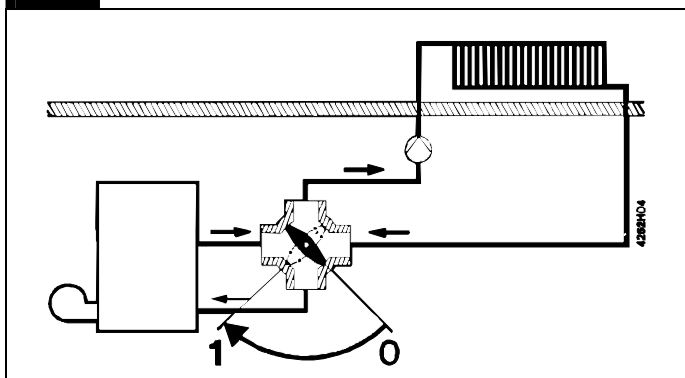

Zasilanie kotła od lewej  
(ustawienie fabryczne)

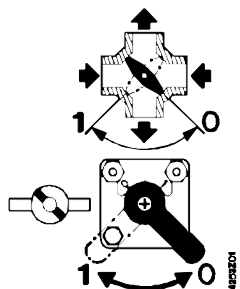

3a

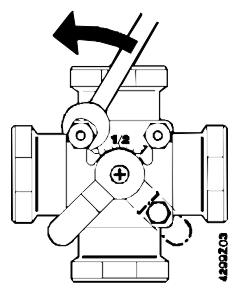

3b

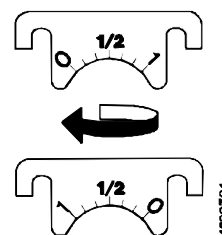

3c

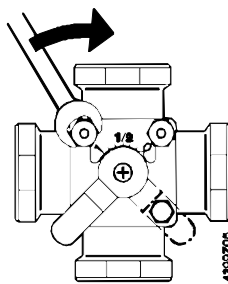

3d

