

SIEMENS



RDF800...



RDD810...

en Touch Room Thermostats Operating Instructions

zh 触摸屏室内温控器操作手册

BLANK PAGE
空白页

INTRODUCTION

STATUS and OPERATION of the thermostat

SELECTION of available INFO and operating modes

INFORMATION
 1st line: temperature or humidity, values of parameters
 2nd line: parameter numbers, time clock

ADJUSTMENT for temperature setpoint, fan speed, operating modes and settings (for example, Alarm, INFO, etc.)

en







zh

REFERENCE PAGES	TERMINALS		DESCRIPTIONS
	RDD810	RDF800	
APPLICATION	L, N	L, N	AC 230 V Power Supply Mains & Neutral
	-	Y1, Y2	Relay Outputs 1 & 2
INSTALLATION	-	Q1, Q2, Q3	Low, Medium & High Speed, Fan Relay Outputs
	Q11	-	Relay Input (Dry Contacts)
	Q12	-	Relay Normal Close Output (NC)
PARAMETERS	Q14	-	Relay Normal Open Output (NO)
	X1, X2	X1, X2	Universal Inputs 1 & 2
	M	M	Input Reference Ground
	CE+, CE-	CE+, CE-	KNX Bus + and - Terminals







en

zh







STATUS SYMBOLS:

	KEY LOCK		MANUAL OVERRIDE
	ALARM / SERVICE REMINDER		COOLING ACTIVE
	SCHEDULER via bus		HEATING ACTIVE
	FAN ACTIVE	AUX	AUXILIARY HEAT ACTIVE

SELECTION SYMBOLS:

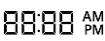
	INDOOR TEMPERATURE		COMFORT MODE
	OUTDOOR TEMPERATURE		ECONOMY MODE
	RELATIVE HUMIDITY		PROTECTION MODE

OPERATIONAL ICONS:

	INCREMENT, DECREMENT OR SELECTION
	SELECTION OR MOVE TO NEXT ITEMS
	TEMPERATURE, RELATIVE HUMIDITY OR PARAMETER VALUES, ETC.
	TIME CLOCK (12 / 24 HOUR), PARAMETER NUMBER OR PASSWORD, ETC.
	SETPOINT MODE (TEMPERATURE ONLY)
	FAN MODE or FAN SPEED MODE
	OPERATING MODE
	SETTING MODE

COMMISSIONING: Download via ETS

1. Dipswitch setting
2. First power up

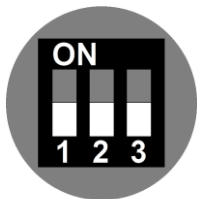

All in OFF positions

3. Touch & hold this icon > 5 s to enter Programming mode

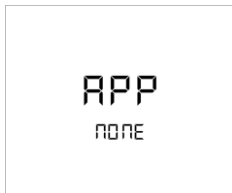

"NONE" means that no application being downloaded or selected before

4. Ready for downloading address & application

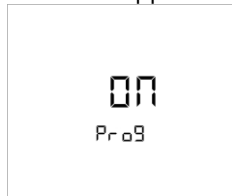

Touch "ON" to exit

en

zh

COMMISSIONING: Local via Dip Switches

1. Set application via dipswitches
2. First power up

en

zh

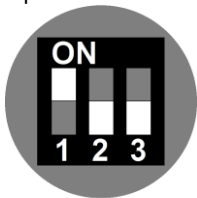

Refer to 

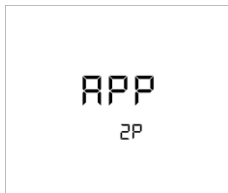

Unit shows selected application
Refer to table below for details.

3. Configure basic control parameters via Wizard

See Configure Parameters via Wizard on next page

Display	Applications
APP 2P	2-PIPE
APP 2PEH	2-PIPE with ELECTRIC HEATER
APP 4P	4-PIPE
APP 2P3P	2-PIPE with 3-POSITION OUTPUT
APP H	HEATING (RDD810KN only)

CONFIGURE PARAMETERS via WIZARD

2. ◀ or ▶ to advance/return to any parameter
+ or - to select any desired available values*

en

zh

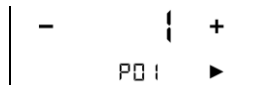

**P01: CONTROL
SEQUENCE**

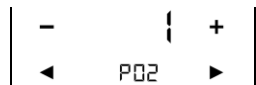

**P02: USER OPERATING
MODE**



**P04: SELECTION OF
°C OR °F**



P06: STANDARD DISPLAY



P07: DISPLAY INFO LINE

en

- 0 +
◀ P15 ▶

**P15: FAN STAGE IN
DEADZONE
(COMFORT MODE)**

zh

- 3 +
◀ P38 ▶

**P38: FUNCTIONALITY OF
X1**

- 00 +
◀ P39 ▶

**P39: OPERATING ACTION
OF X1 AS DIGITAL
INPUTS**

- 1 +
◀ P40 ▶

**P40: FUNCTIONALITY OF
X2**

- 00 +
◀ P41 ▶

**P41: OPERATING ACTION
OF X2 AS DIGITAL
INPUTS**

◀ END ▶

END OF WIZARD SETUP

* Refer to  for the parameter values & meanings

SCREEN SAVER / SELECTION SCREEN

1. Screen saver

24.5 °C

2. Touch digits / screen



3. Selection screen

Comfort
Mode →

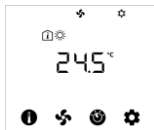

Economy
Mode →



IF UNIT in PROTECTION MODE

1. Screen saver

OFF

2. Touch digits / screen



3. Unit being turned ON

ON

4. Setpoint mode

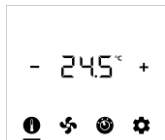

en

zh

CHANGE ROOM TEMPERATURE SETPOINT

1. Touch icon

2. Press **+** or **-** to adjust:

en

zh

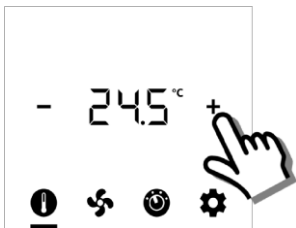

ADJUST FAN MODE / FAN SPEED

1. Touch icon

2. Press **+** or **-** to adjust:



- A:** Auto
- 1:** Low
- 2:** Medium
- 3:** High

CHANGE OPERATING MODES

1. Touch icon
2. Press **+** or **-** to select:



 Comfort



 Economy



 Protection

en

zh

SELECT ADDITIONAL INFO

1. Touch Icon
2. Press **+** or **-** to adjust:



Icons will be shown
if info is available



Indoor
Temperature



Outdoor
Temperature



Relative
Humidity

MANUAL HEAT/COOL CHANGEOVER (P01=2)

1. Touch icon 2. Press **+** or **-** to change

en

zh



Heating
Mode



Cooling
Mode

PARAMETER MODE ACCESS

1. Touch icon & hold > 5 s 2. Enter first password via ◀ or ▶

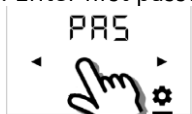

PAS: Password



Factory: 00 00

3. Enter second password via ◀ or ▶



4. After 3 seconds

Note: Press the Setting icon to EXIT or re-enter the password if not correct

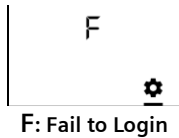
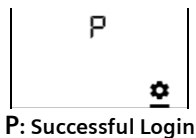

en

zh

5. Editing parameters

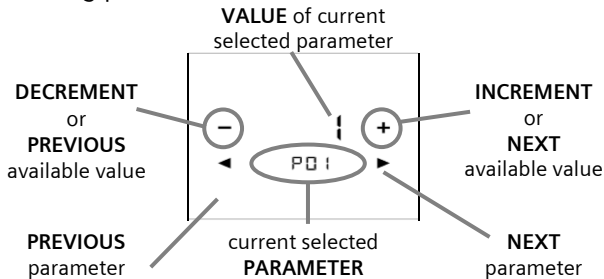

6. Exit parameter mode

EXIT by touching Setting mode icon



NOTE: modify password via system only



User Level Control Parameters

FUNCTION DESCRIPTIONS	RANGE	FACTORY SETTINGS
P01 Control Sequence (RDF800... only)	0: Heating only 1: Cooling only 2: Manual changeover 3: Auto changeover 4: Heating and Cooling	2-pipe = 1 4-pipe = 4
P02 User Operating Mode Profile	1: COMF > PROT 2: COMF > ECON > PROT	1
P04 Selection of °C or °F	0: °C 1: °F	0
P05 Sensor Calibration	-3...3 K	0 K
P06 Standard Display	0: Room temperature 1: Setpoint	0
P07 Display Info Line (2 nd Line of LCD Display)	0: --- (No display) 3: Time of day (12h) via bus 4: Time of day (24h) via bus	0
P08 Comfort Setpoint	5...40 °C	21 °C
P09 Comfort Min. Setpoint	5...40 °C	5 °C
P10 Comfort Max. Setpoint	5...40 °C	35 °C
P11 Econ Heating Setpoint	OFF, 5...WcoolEco WcoolEco = 40°C Max.	15 °C
P12 Econ Cooling Setpoint (RDF800... only)	OFF, WheatEco...40°C WheatEco = 5°C Min.	30 °C

P13	Electric Heater in Cooling Mode (RDF800... only)	ON: Enabled OFF: Disabled	ON
P14	Keylock Function	0: Unlock 1: Total lock 2: Setpoint	0
P15	Fan Stage in Deadzone (Comfort Mode) (RDF800... only)	0: Fan OFF 1: Fan speed 1 Heat / Cool 2: Fan speed 1 Cool only	0
P16	Buzzer Function	OFF: Disable ON: Enable	ON



Installer Level Control Parameters



P38	Functionality of X1 and X2	0: --- No function 1: Ext / Return Temp (AI) 2: H/C changeover (AI/DI) 3: Window open detect (DI) 4: Dew point sensor (DI) 5: Enable electr. Heater (DI) 6: Fault input (DI) 7: Monitor input (Digital) 8: Monitor input (Temp) 10: Presence detection (DI)	P38 → X1 = 3 P40 → X2 = 1
P39	Operating action of X1, X2 as digital inputs	NO: Normally Open / Open NC: Normally Close / Close	P39: X1=NO P41: X2=NO
P71	Reload factory setting	OFF: Disable ON: Reload Start	OFF



RDF800... RDD810...

ALARMS & SERVICE REMINDERS (IF ANY)

1. Touch icon

2. Press ◀ or ▶ to view

en

zh



BUS
5000

Bus Power
Supply

AL 1
9001

Ext. Alarms
1 & 2

FIL
3911

Clean Filter

PRIORITY	ALARM/SERVICE	DISPLAY	ERROR CODE	TYPE
1	Bus Power Supply	BUS	5000	Fault
2	Condensation	CON	4930	
3	Ext Fault Input 1	AL1	9001	
4	Ext Fault Input 2	AL2	9002	
5	Clean Filter Reminder (Use + / - to remove reminder)	FIL	3911	Service

BLANK PAGE
空白页

BLANK PAGE
空白页

介绍

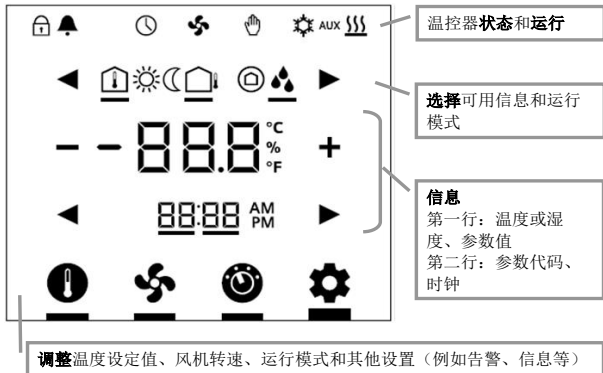







en
zh

参考页	端子		说明
	RDD810	RDF800	
应用	L, N	L, N	AC 230 V 电源和中性线
	-	Y1, Y2	中继输出 1; 中继输出 2
安装	-	Q1, Q2, Q3	低速、中速和高速, 风机中继输出
	Q11	-	中继输入 (干触点)
	Q12	-	中继常闭输出 (NC)
参数	Q14	-	中继常开输出 (NO)
	X1, X2	X1, X2	通用输入 1; 通用输入 2
	M	M	输入信号接地
	CE+, CE-	CE+, CE-	KNX 总线 + 和 - 端子









状态图标:

	按键锁定		手动强制转换
	告警 / 服务提醒		制冷开启
	通过总线传输过来的时间表		供热开启
	风机开启	AUX	辅助供热开启

选择图标:

	室内温度		舒适模式
	室外温度		节能模式
	相对湿度		保护模式

运行图标:

	调高、调低或选择
	选择或切换到下一条目
	温度、相对湿度或参数值等
	时钟(12 / 24 小时)、参数、数值或密码等
	设定值模式 (仅限温度)
	风机模式或风机转速模式
	运行模式
	设置模式

调试：通过 ETS 下载

1. 拨码开关设置

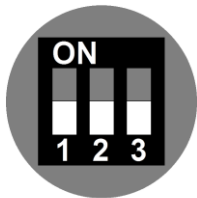

全部置于 OFF 位

2. 初次上电

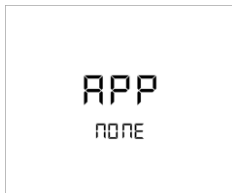

NONE 表示无正在下载的应用或之前选择的应用

en

zh

3. 按住图标超过 5 秒 进入编程模式



4. 地址和应用下载就绪



触摸“ON”退出

调试：通过拨码开关在本地进行

1. 通过拨码卡关设置应用
2. 初次上电

en

zh

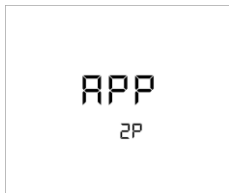
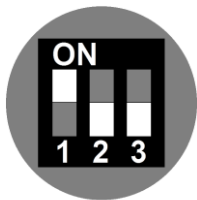

显示所选应用，详见下表：



参见

3. 根据提示配置基本参数

参见下页内容

屏幕显示	应用
APP 2P	两管制
APP 2PEH	两管制，带电加热
APP 4P	四管制
APP 2P3P	两管制，三位输出
APP H	供热 (仅限 RDD810KN)

根据提示配置参数

2. ◀ 或 ▶ 向前 / 向后切换到任一参数
+ 或 - 按需选择任何可用数值*

en

zh

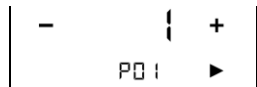

P01: 控制逻辑

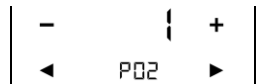

P02: 用户运行模式



P04: °C 或 °F 的选择



P06: 标准显示



P07: 显示信息行

en

- 0 +
◀ P15 ▶

**P15: 死区下的风机转速
(舒适模式)**

zh

- 3 +
◀ P38 ▶

P38: X1 的功能

- 00 +
◀ P39 ▶

**P39: X1 作为数字输入的
运行功能**

- 1 +
◀ P40 ▶

P40: X2 的功能

- 00 +
◀ P41 ▶

**P41: X2 作为数字输入的
运行功能**

◀ End

配置结束

* 参见  页上的参数值和含义

屏幕保护 / 选择屏幕

1. 屏幕保护

24.5 °C

2. 触摸数字 / 屏幕



3. 选择屏幕

舒适
模式 →



节能
模式 →



如果温控器处于保护模式

1. 屏幕保护

OFF

2. 触摸数字 / 屏幕



3. 温控器正在激活

ON

4. 设定值模式

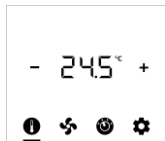

en

zh

更改室内温度设定值

1. 触摸图标

2. 按 **+** or **-** 调整

en

zh

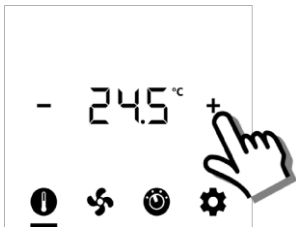

调整风机模式 / 风机转速

1. 触摸图标

2. 按 **+** or **-** 调整



A: 自动

1: 低速

2: 中速

3: 高速

更改运行模式

1. 触摸图标



2. 按 + or - 选择

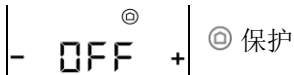
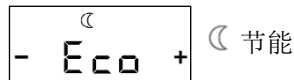
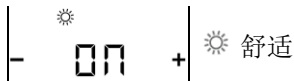

en

zh

选择其他信息

1. 触摸图标



2. 按 + or - 调整:



仅显示有效信息的图标

手动供热 / 制冷转换 (P01=2)

1. 触摸图标
2. 按 **+** 或 **-** 更改:

en



供热模式

zh



制冷模式

进入参数模式

1. 按住图标超过 5 秒
2. 通过 ◀ 或 ▶ 输入密码第一个数值



PAS: 密码



出厂: 00 00



3. 通过 ◀ 或 ▶ 输入密码第二个数值



4. 3 秒后

注：按设置图标退出密码输入；若密码输入错误，可重复输入



P: 登录成功



F: 登录失败

en

zh

5. 编辑参数

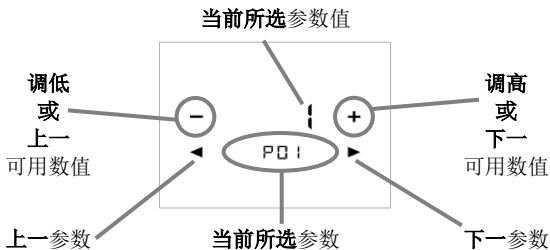

6. 退出参数模式

触摸设置图标退出

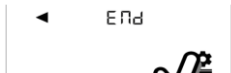

注意：仅可通过系统修改参数



用户级控制参数

	功能说明	范围	出厂设置
P01	控制逻辑 (仅限 RDF800...)	0: 仅限供热 1: 仅限制冷 2: 手动转换 3: 自动转换 4: 供热与制冷	两管制 = 1 四管制 = 4
P02	用户运行模式优先级	1: 舒适 > 保护 2: 舒适 > 节能 > 保护	1
P04	°C 或 °F 的选择	0: °C 1: °F	0
P05	传感器校验	-3...3 K	0 K
P06	标准显示	0: 室内温度 1: 设定值	0
P07	屏幕显示信息行 (LCD 显示的第二行)	0: --- (无显示) 3: 通过总线传输的时间 (12 小时) 4: 通过总线传输的时间 (24 小时)	0
P08	舒适模式设定值	5...40 °C	21 °C
P09	舒适模式最低设定值	5...40 °C	5 °C
P10	舒适模式最高设定值	5...40 °C	35 °C
P11	节能模式供热设定值	OFF, 5...WcoolEco WcoolEco = 40°C max	15 °C
P12	节能模式制冷设定值 (仅限 RDF800...)	OFF, WheatEco...40°C WheatEco = 5°C min	30 °C

P13	制冷模式下的电加热器 (仅限 RDF800...)	ON: 启用 OFF: 禁用	ON
P14	按键锁定	0: 解锁 1: 全部锁定 2: 设定值	0
P15	死区下的风机转速 (舒适模式) (仅限 RDF800...)	0: 风机关闭 1: 风机转速 1 供热 / 制冷 2: 风机转速 1 仅限制冷	0
P16	蜂鸣器功能	OFF: 禁用 ON: 启用	ON



安装级控制参数



操作需要暖通空调知识

P38 P40	X1 和 X2 功能  RDF800... RDD810...	0: -- 无功能 1: 外部温度 / 回风温度 (模拟输入) 2: 供热 / 制冷转换 (模拟输入 / 数字输入) 3: 开窗监测 (数字输入) 4: 露点传感器 (数字输入) 5: 支持电加热器 (数字输入) 6: 错误输入 (数字输入) 7: 监测输入 (数字输入) 8: 监测输入 (温度) 10: 存在监测 (数字输入)	P38 → X1 = 3 P40 → X2 = 1
P39 P41	X1, X2 作为数字输入 的运行功能	NO: 常开 / 开启 NC: 常闭 / 关闭	P39: X1 = NO P41: X2 = NO
P71	恢复工厂设置模式	OFF: 禁用 ON: 启用	OFF

告警和服务提醒（如果存在）

1. 触摸图标

2. 按 ◀ 或 ▶ 查看：

en

zh



BUS
5000

总线电源

AL 1
9001

外部告警 1 和
外部告警 2

FIL
3911

清洗过滤网

优先级	告警 / 服务	显示	错误代码	类型
1	总线电源	BUS	5000	故障
2	结露	CON	4930	
3	外部故障输入 1	AL1	9001	
4	外部故障输入 2	AL2	9002	
5	清洗过滤网提醒 (按 +/- 清除提醒)	FIL	3911	服务

BLANK PAGE
空白页

BLANK PAGE
空白页



RDD810...

en	Heating	it	Riscaldamento
zh	供热	es	Calefacción
de	Heizung	tr	Isitma
fr	Chauffage	ru	Отопление

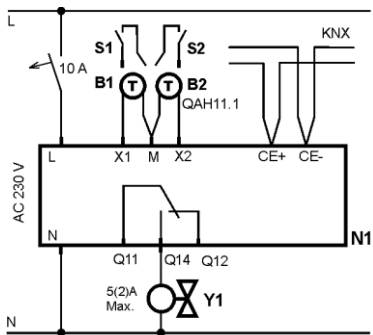



RDF800...

en	2-pipe, 3 position output	it	2-tubi, uscita 3-punti
zh	两管制，三位控制输出	es	2-tubos, salida a 3 puntos
de	2-Rohr, 3-Punkt-Ausgang	tr	2-borulu, 3-konumlu çikis
fr	2 tubes, sortie 3pts	ru	2-трубный с 3-точечным выходом



1	2	3
OFF	ON	OFF

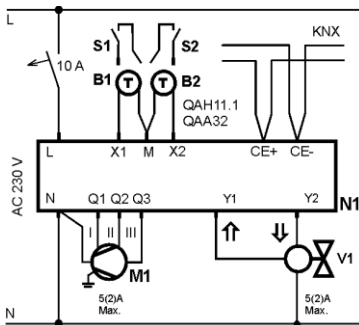



RDF800...

en	4-pipe fan coil	it	Fan coil 4 tubi
zh	四管制	es	Fancoil a 4 tubos
de	4-Rohr Ventilator-konvektor	tr	4 borulu fan coil
fr	Ventiloconvecteur 4 tubes	ru	4-трубный фэнкойл



1	2	3
OFF	OFF	ON

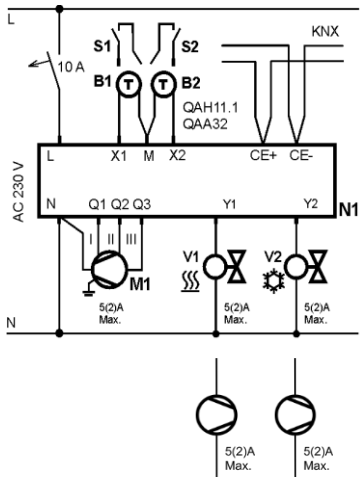



RDF800...

en	2-pipe & el. heater	it	2 tubi con batteria elettrica
zh	两管制，带电加热	es	2 tubos & batería eléctrica
de	2-Rohr & Elektroheizer	tr	2 borulu & elk. Isıtıcı
fr	2 tubes & batterie électrique	ru	2-трубный фэнкойл с электронагревателем



1	2	3
ON	ON	OFF

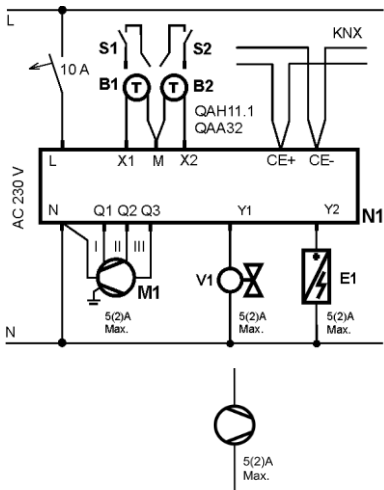



RDF800...

en	2-pipe fan coil	it	Fan coil 2 tubi
zh	两管制	es	Fancoil a dos tubos
de	2-Rohr Ventilator-konvektor	tr	2 borulu fan coil
fr	Ventiloconvecteur 2 tubes	ru	2-трубный фанкойл



1	2	3
ON	OFF	OFF

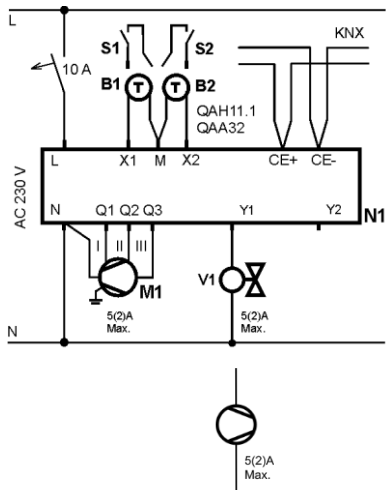

a

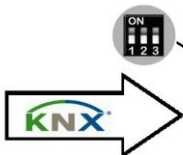

p

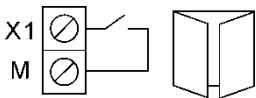

P38 = 3

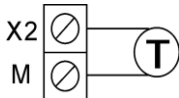

P40 = 1



RDF800KN/NF, RDD810KN/NF

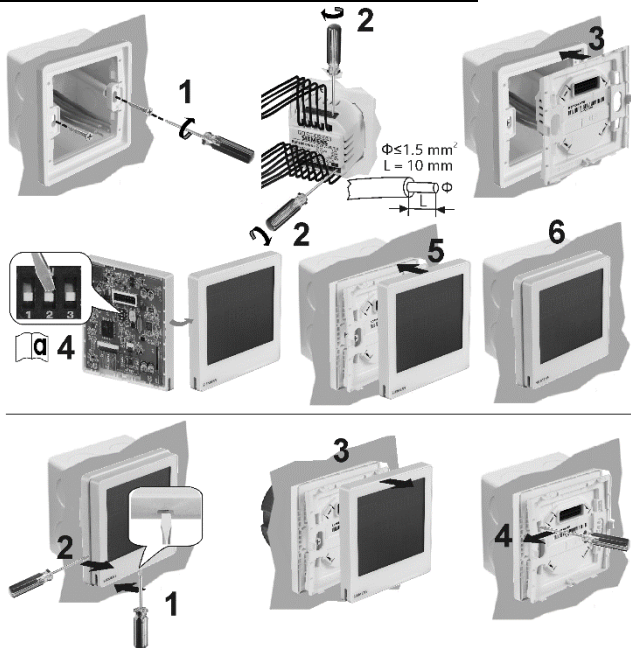

 **RDF800KN**

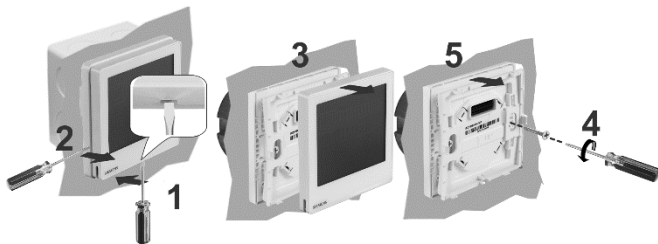
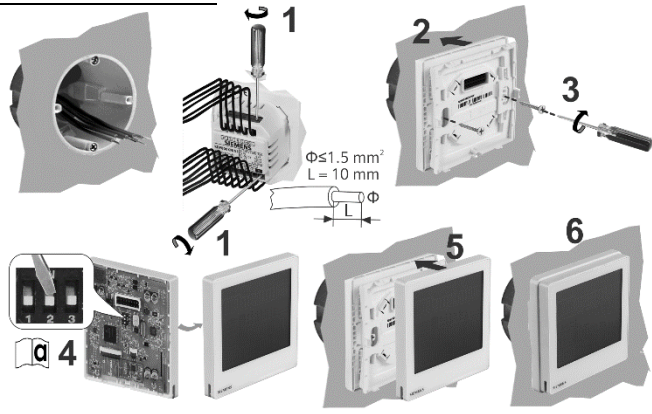

Issued by
Siemens Switzerland Ltd
Smart Infrastructure
Global Headquarters
Theilerstrasse 1a
CH-6300 Zug
Tel. +41 58 724 2424
www.siemens.com/buildingtechnologies

© Siemens Switzerland Ltd, 2014 - 2021
Technical specifications and availability subject
to change without notice.

- en** Touch Room Thermostats Installation Instructions
- zh** 触摸屏室内温控器安装手册
- de** Installationsanleitung
- fr** Instructions d'installation
- it** Istruzioni di montaggio
- es** Instrucciones de montaje
- tr** Kurulum talimatları
- ru** Сенсорный комнатный термостат Инструкция по монтажу

